



SLIDING DOOR | LOCKS & ACCESSORIES

DS2400 | MORTICE SLIDING PATIO DOOR FURNITURE

The DS2400 furniture is a showcase of Doric's clean & contemporary aesthetic style.

The DS2400 handle range has the flexibility for various configurations and handle shapes.

The patio door furniture features simple snib operation as well as a clean and contemporary aesthetic, ideal for apartment and residential application.

ADVANTAGES

- Range of handle shapes and configurations
- Padlock symbol assists with indicating if furniture is locked or unlocked - non obtrusive
- Low profile handle shapes
- Powder coating offers high range of colour matching options

COLOURS



PRODUCT DETAILS

FURNITURE MATERIAL

Aluminium

FINISH AVAILABLE

Powder coat

HOW TO ORDER

INTERNAL HANDLE SHAPE	CONFIGURATIONS	COLOUR	EXTERNAL HANDLE SHAPE	CYLINDER	LOCK BODY	PACKER
D Grab Slim Grab or Slim Non Grab	Double Lockset (Int & Ext cyl) Latch Set (no cyl) Lock Set (Ext cyl) Lock Set (Int cyl) or Dummy (no cyl)	Black White or Silver	D Grab Slim Grab or Slim Non Grab	DS196NSK - 62mm DS200NSK - 70mm DS250 - half cyl	DS2400	1mm 1.8mm 2mm 6.32mm 8.5mm

FURNITURE RANGE



D GRAB



SLIM GRAB



SLIM NON GRAB

ADDITIONAL HARDWARE

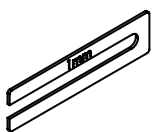

DS2400/SP1
PACKER

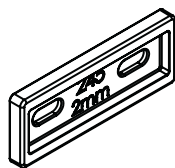

DS2400/SP2
PACKER

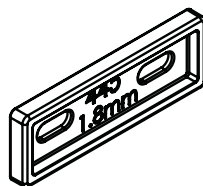

DS2400/SP3
PACKER

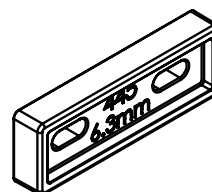



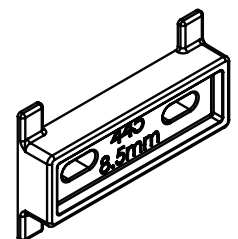





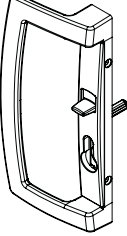
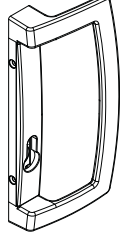

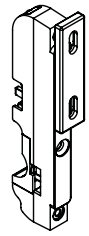
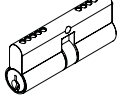
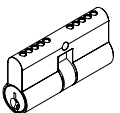
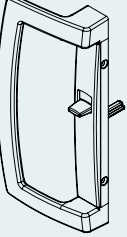
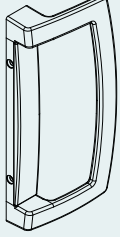

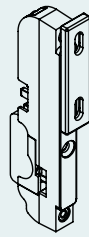
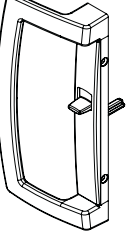
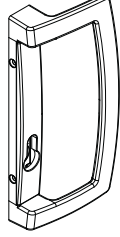
DS2400/SP4
PACKER

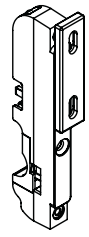
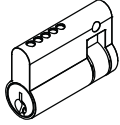
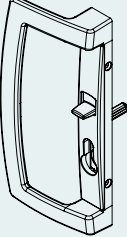



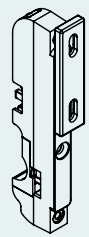
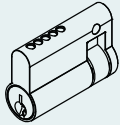
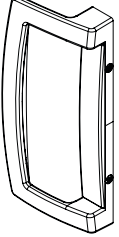
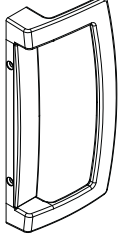
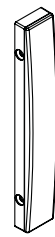





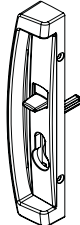
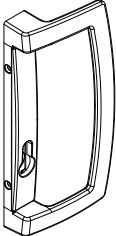

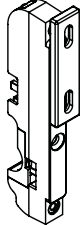
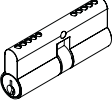
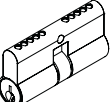
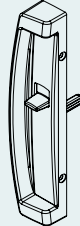



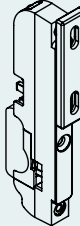
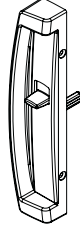
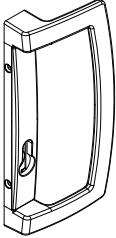

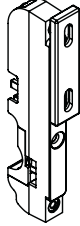
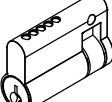
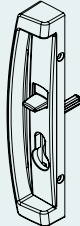
DS2400/SP5
PACKER



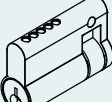

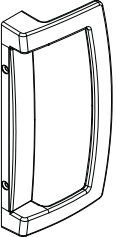

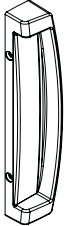



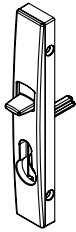
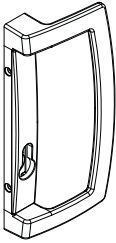

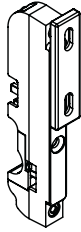
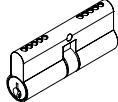
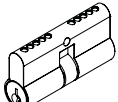
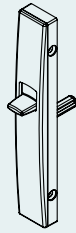

DS2400 | D GRAB SERIES ORDERING OPTIONS

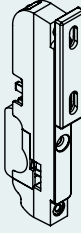
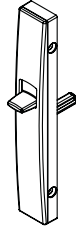
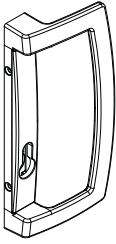
LOCK FUNCTION	INTERNAL FURNITURE OPTIONS	EXTERNAL FURNITURE OPTIONS				LOCK BODY W/KEEPER	CYLINDER
MDS2400DG Double Lockset (Interior & exterior cylinder)	 DS2412 Locking with Snib	 DS2428 Locking	 DS2424 Locking	 DS2426 Locking	 DS2400 Mortice Lockbody	 DS200NSK  DS196NSK	
MDS2401DG Latch Set (No cylinder)	 DS2413 Latching	 DS2429 Latching/ Dummy	 DS2425 Latching/ Dummy	 DS2427 Latching/ Dummy	 Mortice Lockbody Latch Version	Not Required	
MDS2402DG Lock Set (Exterior cylinder only with internal Snib)	 DS2413 Latching	 DS2428 Locking	 DS2424 Locking	 DS2426 Locking	 DS2400 Mortice Lockbody	 DS250	
MDS2405DG Lock Set (Internal Snib and internal cylinder only)	 DS2412 LOCKING with SNIB	 DS2429 Latching/ Dummy	 DS2425 Latching/ Dummy	 DS2427 Latching/ Dummy	 DS2400 Mortice Lockbody	 DS250	
MDS2408DG Dummy Handle Set (No cylinder)	 DS2431 DUMMY	 DS2429 Latching/ Dummy	 DS2425 Latching/ Dummy	 DS2427 Latching/ Dummy	Not Required	Not Required	

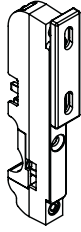
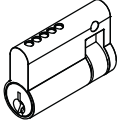
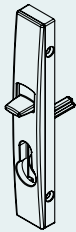
DS2400 | SLIM GRAB SERIES ORDERING OPTIONS

LOCK FUNCTION	INTERNAL FURNITURE OPTIONS	EXTERNAL FURNITURE OPTIONS				LOCK BODY W/KEEPER	CYLINDER
MDS2400 SG Double Lockset (Interior & exterior cylinder)	 DS2416 Locking with Snib	 DS2428 Locking	 DS2424 Locking	 DS2426 Locking	 DS2400 Mortice Lockbody	 DS200NSK  DS196NSK	
MDS2401 SG Latch Set (No cylinder)	 DS2417 Latching	 DS2429 Latching/ Dummy	 DS2425 Latching/ Dummy	 DS2427 Latching/ Dummy	 Mortice Lockbody Latch Version	Not Required	
MDS2402 SG Lock Set (Exterior cylinder only with internal Snib)	 DS2417 Latching	 DS2428 Locking	 DS2424 Locking	 DS2426 Locking	 DS2400 Mortice Lockbody	 DS250	
MDS2405 SG Lock Set (Internal Snib and internal cylinder only)	 DS2416 Locking with SNIB	 DS2429 Latching/ Dummy	 DS2425 Latching/ Dummy	 DS2427 Latching/ Dummy	 DS2400 Mortice Lockbody	 DS250	
MDS2408 SG Dummy Handle Set (No cylinder)	 DS2433 Dummy	 DS2429 Latching/ Dummy	 DS2425 Latching/ Dummy	 DS2427 Latching/ Dummy	Not Required	Not Required	

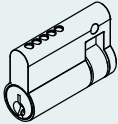
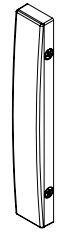
DS2400 | SLIM NON GRAB SERIES ORDERING OPTIONS

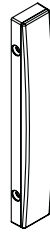
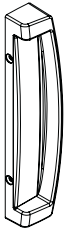
LOCK FUNCTION	INTERNAL FURNITURE OPTIONS	EXTERNAL FURNITURE OPTIONS			LOCK BODY W/KEEPER	CYLINDER
MDS240 0 SNG Double Lockset (Interior & exterior cylinder)	 DS2414 Locking with Snib	 DS2428 Locking	 DS2424 Locking	 DS2426 Locking	 DS2400 Mortice Lockbody	 DS200NSK  DS196NSK
MDS240 1 SNG Latch Set (No cylinder)	 DS2415 Latching	 DS2429 Latching/ Dummy	 DS2425 Latching/ Dummy	 DS2427 Latching/ Dummy	 Mortice Lockbody Latch Version	Not Required
MDS240 2 SNG Lock Set (Exterior cylinder only with internal Snib)	 DS2415 Latching	 DS2428 Locking	 DS2424 Locking	 DS2426 Locking	 DS2400 Mortice Lockbody	 DS250
MDS240 5 SNG Lock Set (Internal Snib and internal cylinder only)	 DS2414 Locking with Snib	 DS2429 Latching/ Dummy	 DS2425 Latching/ Dummy	 DS2427 Latching/ Dummy	 DS2400 Mortice Lockbody	 DS250
MDS240 8 SNG Dummy Handle Set (No cylinder)	 DS2432 Dummy	 DS2429 Latching/ Dummy	 DS2425 Latching/ Dummy	 DS2427 Latching/ Dummy	Not Required	Not Required

TECHNICAL DRAWING

D GRAB

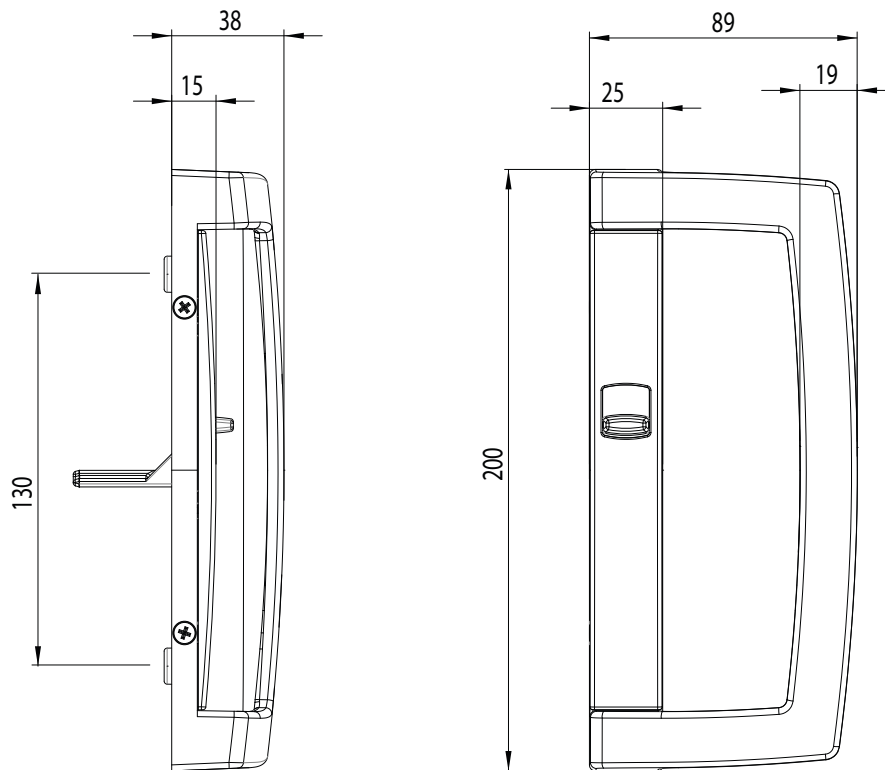

SLIM GRAB

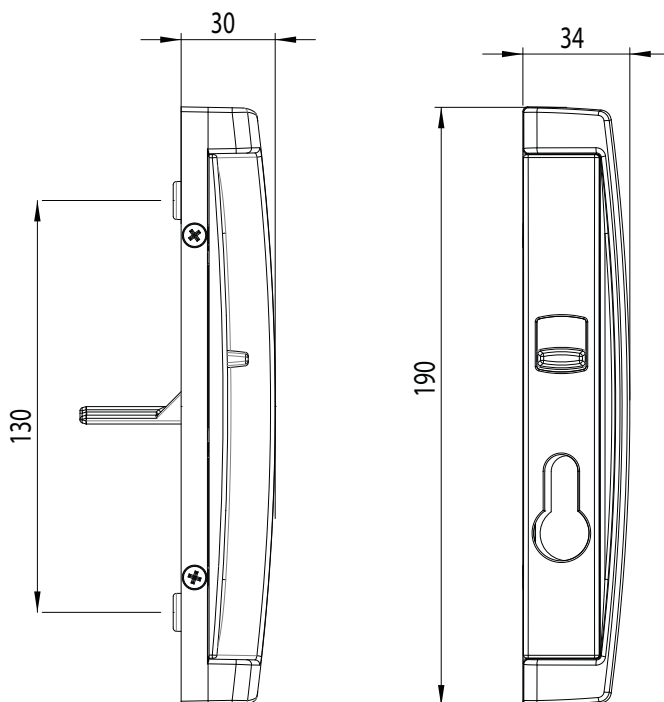

SLIM NON GRAB

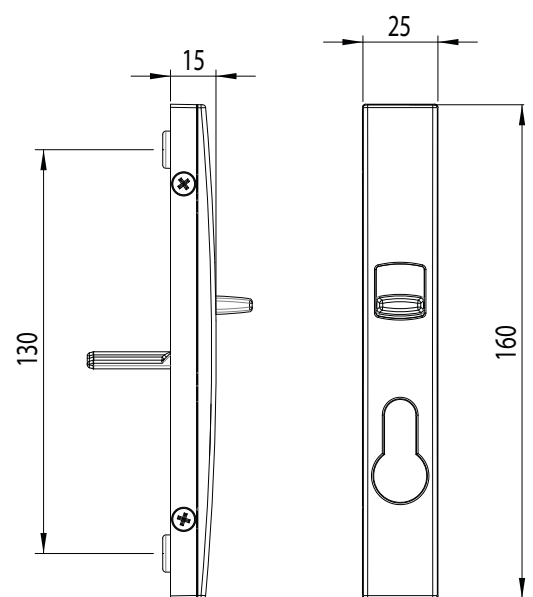

DS2400 | MORTICE SLIDING DOOR LOCK BODY

The DS2400 is a market leading high performance small form mortice lock body.

The DS2400 lock body is a single point mortice lock body designed to provide a high level of performance, while fitting into a wide range of extrusions.

ADVANTAGES

- Small form
- Ability for snibbing
- Anti-crash feature
- Two stage key locking
- Compatible with a range of furniture options

TESTING

- Tested to 100,000 cycles
- Exceeded 3000N Ultimate test

COLOURS



SILVER



PRODUCT DETAILS

LOCKBODY MATERIAL	Powder coated Zinc
CYLINDER	Lazy/floating cam euro pin cylinder
STRIKE ADJUSTMENT	8mm Vertical

HOW TO ORDER

INTERNAL HANDLE SHAPE	CONFIGURATIONS	COLOUR	EXTERNAL HANDLE SHAPE	CYLINDER	LOCK BODY	PACKER
D Grab Slim Grab or Slim Non Grab	Double Lockset (Int & Ext cyl) Latch Set (no cyl) Lock Set (Ext cyl) Lock Set (Int cyl) or Dummy (no cyl)	Black White or Silver	D Grab Slim Grab or Slim Non Grab	DS196NSK - 62mm DS200NSK - 70mm DS250 - half cyl	DS2400	1mm 1.8mm 2mm 6.32mm 8.5mm

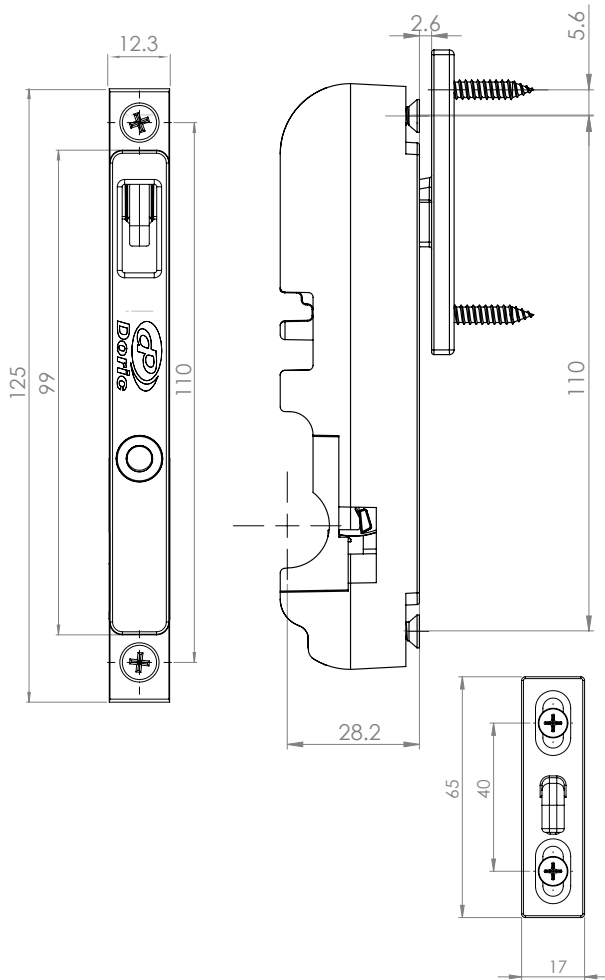

CONFIGURATIONS

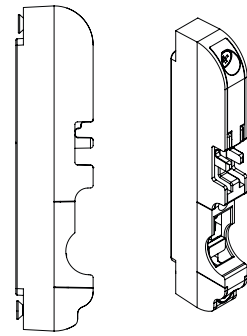

LOCK VERSION

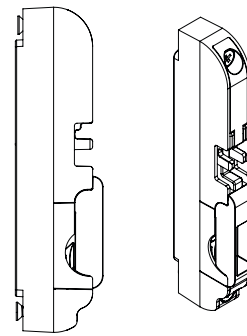

LATCH VERSION

COMPATIBLE FURNITURE



DS2400 PATIO FURNITURE



DS2480
SNIB LOCK
FURNITURE



VARIOUS EURO
CYLINDER
ESCUTCHEON

EVOLUTION | SLIDING DOOR & MORTICE LOCK RANGE

The Evolution Sliding Door and Lock is an affordable easy to install lock set that is ideal for residential living.

The Evolution range features an aluminium bodied mortice lock, D pull handle and flush pull set. The range is designed for easy use and simple installation.

The mortice lock body can also be kitted with other Doric pull handles such as the DN194 Black or Stainless steel Pull Handle set.

The twin counteracting beaks engage an all-metal catch plate, providing resistance to jemmying and restrain the door against being lifted externally from its rails

ADVANTAGES

- Can be kitted with a DN194 / 300 mm handle set or the DS575 Flush pull set
- Includes easy to use catch plate drilling jig for exact placement and quick and simple fitting

TESTING

- Performance tested to 50,000 cycles

PRODUCT DETAILS

FURNITURE MATERIAL	Aluminium
FURNITURE AVAILABLE	Evolution D pull handles - BTB Set, with Evolution Flush Pull - Single-sided
CYLINDER	Std Euro Cylinder, DS197 keys 1 to 10 (Deadlock), DS202 (Turn snib) keys 1- 3, DS250 (Half) keys 1-10

COLOURS



BLACK
POWDER
COATED



CUSTOM COLOURS
ON REQUEST

CODE	PULL HANDLE	COLOUR
DN194	Evolution BTB Pull handle set 270mm	Satin Black or Powder coat

CODE	LOCK BODY OPTIONS	COLOUR
DN1290	Lock body with Stainless steel face plate 30mm backset	-
DN1290	Lock body with Stainless steel face plate 40mm backset	-

CODE	ACCESSORIES	COLOUR
DS1253 DS1253SB DS1253SN	Escutcheon set	Powder coat Satin black Satin nickle
DS1255 DS1255SS	Escutcheon set	Powder coat or Stainless steel
DS575 DS575SB	Flush pull	Powder coat or Satin Black

CODE	CYLINDERS	COLOUR
DS197	70mm euro double cylinder fixed cam S/C Key numbers 1-10	-
DS202	70mm (6pin) cylinder & turn euro cylinder Key numbers 1-3	-
DS250	Euro Profile Half Cylinder keys 1-10 (keyed only)	-

D Pull + **Escutcheon**
DN194 + DS1253

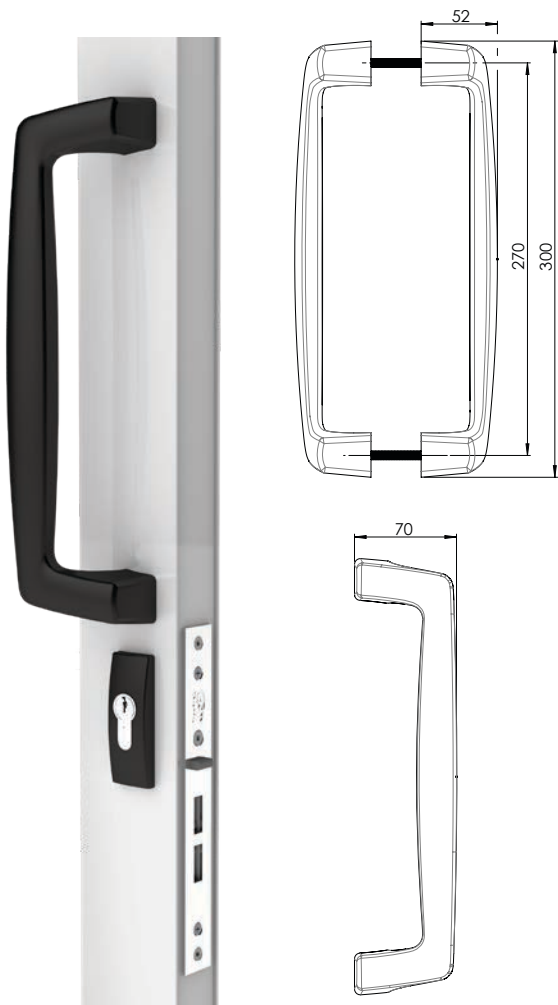

Flush Pull
DS575

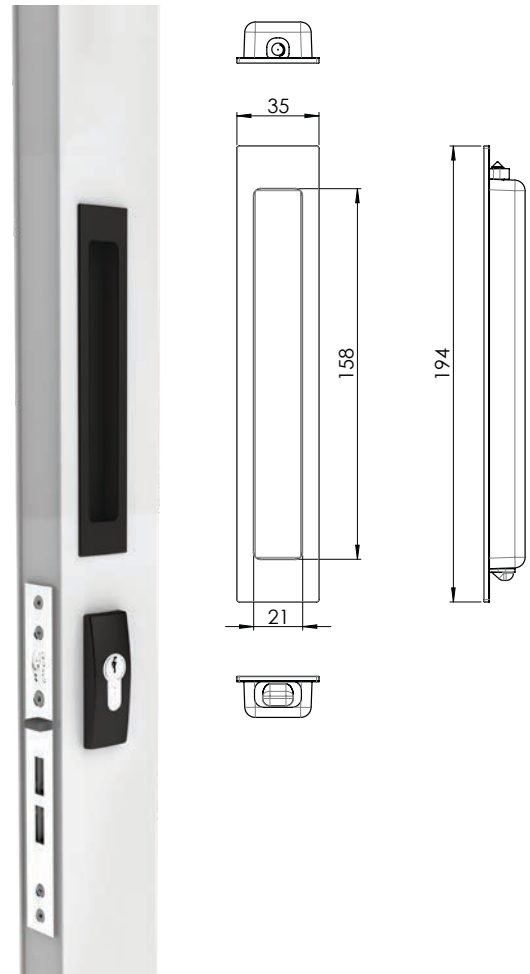

Mortice Lockbody
DN1290/30 & DN1290/40

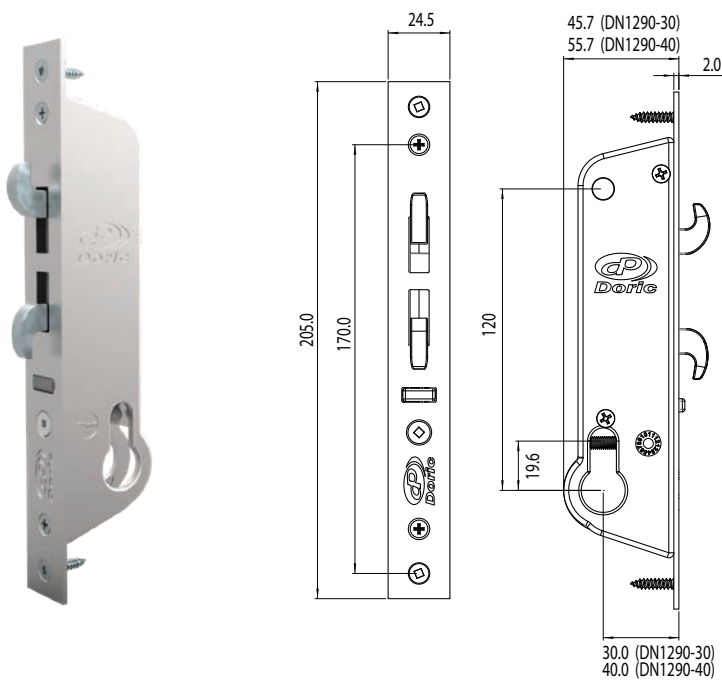

Keeper

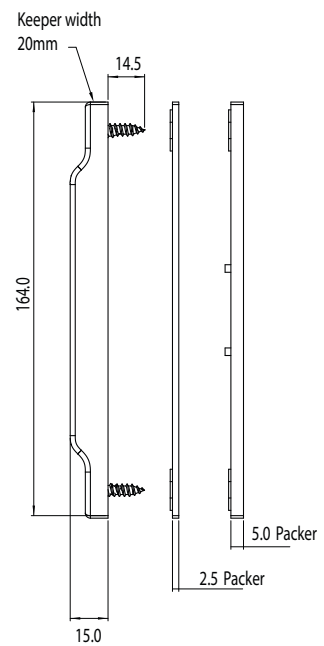

DM1130 | SLIDING DOOR MORTICE LOCKSET

The DM1130 Sliding Door Mortice Lock Set is suitable for use on aluminium doors in residential and commercial applications.

The attractive D Pull furniture provides architectural styling to compliment any sliding door.

ADVANTAGES

- Suitable from 25mm up to 65mm wide aluminium profile
- Centrally locked lock cylinder
- 35mm backset
- External & internal key locking options
- Latching function on the internal furniture
- Anti-lift & anti-crash twin hook tongues provide increased security
- Large ergonomic D Pull furniture handle
- C4 5 pin keyway for convenience
- Keyed alike options available
- Durable powder coated finish
- Suitable for use on double & single sliding doors
- Suits a wide range of exterior pulls from the Doric sliding patio range (optional)

PRODUCT DETAILS

APPLICATION	Double & Sliding Doors
MATERIAL	Aluminium
FINISHES	Powder coat
BACKSET	35mm
INCLUSIONS	Pack includes slaves, keepers and all fixings



HOW TO ORDER

CODE	LOCK SET OPTION	COLOUR
DM1130	Double Cylinder Lock Set (Interior & exterior cylinders)	Black or White
DM1131	Latch Set (no cylinders)	Black or White
DM1132	Exterior Lock Set (Exterior cylinder only)	Black or White
DM1135	Internal Cylinder Lock Set (Interior cylinder only)	Black or White
DM1138	Dummy Set (no cylinder or latching function)	Black or White



DM1130 Double Cylinder Lockset
(Interior & exterior cylinders)



DM1131 Latch Set
(No cylinders)



DM1132 Lock Set
(Exterior cylinder only)



DM1135 Internal Cylinder Lockset
(Interior cylinder only)



DM1138 Dummy Set
(No cylinder or latching function)

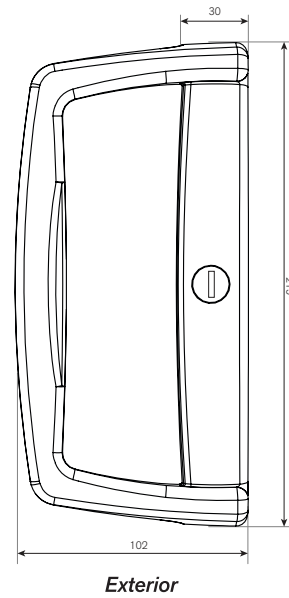

Exterior

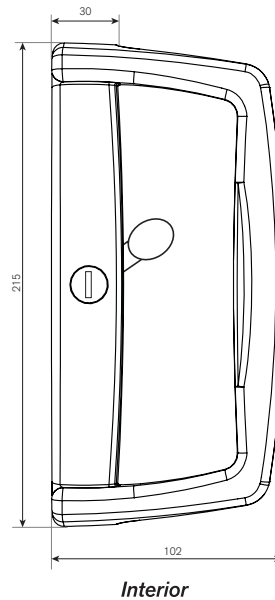

Interior

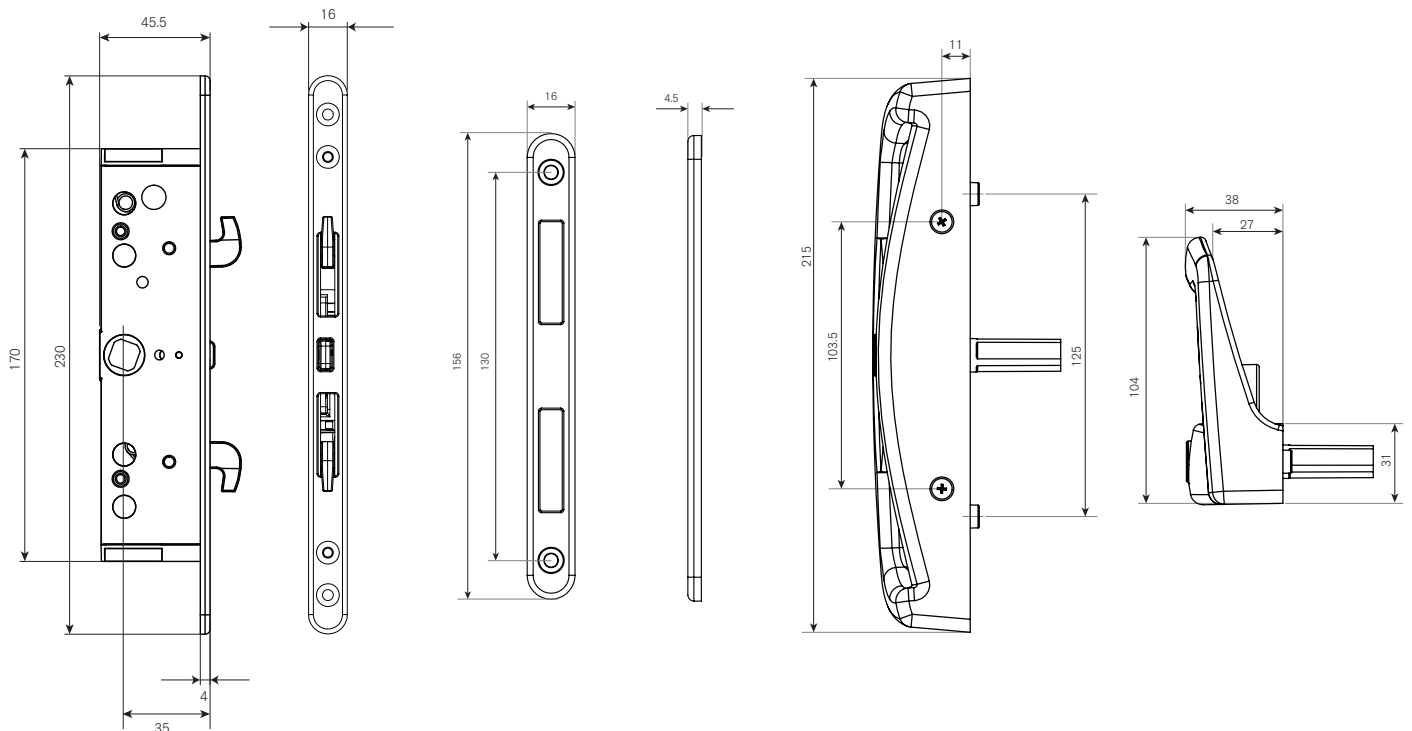

DS276 | IBIS PATIO DOOR LOCK

The DS276 Ibis Patio Door Lock is a sleek and effective solution for your sliding door.

The DS276 Ibis Patio Door Lock delivers a sleek and effective door lock for medium size sliding doors.

Security is essential to all residential homes and commercial units. The Ibis is a revolutionary sliding door lock with enhanced strength and extra safety features such as the anti-drop system; an innovative system which prevents any latch drop if an impact on closing occurs to the lock mechanism.

The DS276 also comes with black or white UV protective powder coating as standard, as well as custom colour available on special request.

ADVANTAGES

- Smooth, effortless operation and control for sliding doors
- Superior UV fade resistant
- It is equipped with an anti-drop system which enhances security
- Excellent structural strength

TESTING

- Performance tested to 50,000 cycles
- Performance tested the Neutral Salt Spray test in accordance with Australian Standard AS2331.3.1
- Tested and proven on strength and performance



COLOURS



SATIN
BLACK

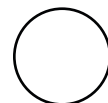

PEARL
WHITE



CUSTOM
COLOURS
AVAILABLE

PRODUCT DETAILS

FURNITURE
MATERIAL

Die Cast Zinc

FINISH
AVAILABLE

Powder coat



DS276

DS275

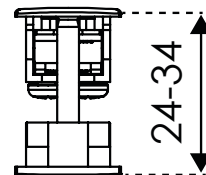
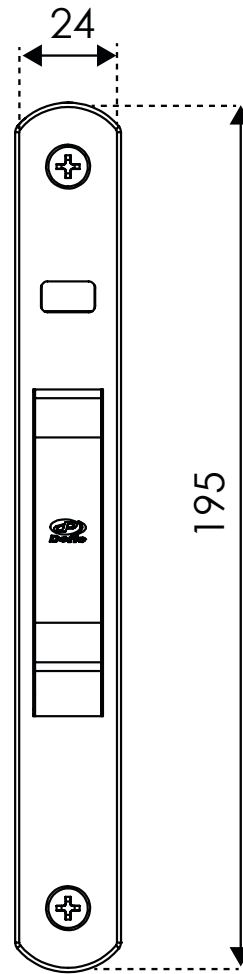

HOW TO ORDER

CODE	COLOUR
DS276 (single point)	Black or White
DS276 (multi point)	Black or White
DS277 (dummy set)	Black or White
DS275 (with cylinder)	Black or White

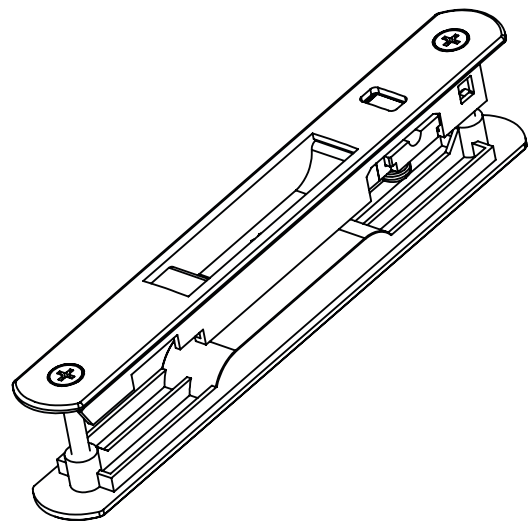

DS890 | EXTERNAL SLIDING DOOR LAYBACK HANDLE

The DS890 is a modern and elegant external handle for sliding doors.

Stylishly designed, the DS890 is a versatile exterior handle for sliding doors suitable with all Doric's surface mounted chassis.

ADVANTAGES

- **DS890:** Resilient Aluminium furniture
- **DS890/2:** 316 Stainless steel for longevity and strength
- Suits all Doric surface mounted chassis.

COLOURS



SATIN BLACK



CUSTOM

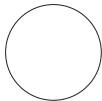

WHITE



PLATED
DS890/2 only



SILVER

HOW TO ORDER

CODE	COLOUR	CYLINDER
MDS890	Black, White, Silver, Custom	DS173 or DS188
MDS890/2	Powder coat: Black, White, Silver, Custom, Plated: Bright Chrome, Satin Nickel, Satin Chrome	DS173 or DS188



PRODUCT DETAILS

	DS890	DS890/2
FURNITURE MATERIAL	Aluminium	Stainless steel
FINISH AVAILABLE	Powder coat	Powder coat or Plated
CYLINDER	Suits pin and wafer cylinders	
LAYBACK	15 degree	
FIXING	Screw posts centre to centre – 82mm. M5 screws not included.	

The DS891 offers a non-keyed external handle for sliding doors.

With the same design features as the DS890, the DS891 offers the non-keyed version of the versatile exterior handle for sliding doors.

ADVANTAGES

- **DS891:** Resilient Aluminium furniture
- **DS891/2:** 316 Stainless steel for longevity and strength
- Suits all Doric surface mounted chassis.

COLOURS



HOW TO ORDER

CODE	COLOUR
MDS891	Black, White, Silver, Custom
MDS891/2	Powder coat: Black, White, Silver, Custom, Plated: Bright Chrome, Satin Nickle, Satin Chrome



PRODUCT DETAILS

	DS891	DS891/2
FURNITURE MATERIAL	Aluminium	Stainless steel
FINISH AVAILABLE	Powder coat	Powder coat or Plated
LAYBACK	15 degree	
FIXING	Screw posts centre to centre – 82mm. M5 screws not included.	



DORIC'S ROLLER SERIES FOR A RANGE OF SLIDING DOORS.

High performance adjustable rollers engineered for superior corrosion resistance and durability.



DR1000 ROLLER SERIES

For residential and commercial sliding door applications.

Suits aluminium, timber and UPVC sliding doors up to 100kg

Manufactured to offer superior corrosion resistance & durability

Polymer roller with 'ZZ' bearing for corrosion free operation

10mm height adjustable carriage with Stainless steel adjusting screw



DR2000 ROLLER SERIES

For residential aluminium and timber sliding door applications.

Suits aluminium and timber sliding doors up to 200kg

Manufactured to offer superior corrosion resistance & durability

High performance roller with Doric's new Ryvelin tyre.

'ZZ' ground precision bearing with dust seal for corrosion free operation

10mm height adjustable carriage with Stainless steel adjusting screw



DR4000 ROLLER SERIES

High performance quad roller with smooth operation and durability.

Suits larger aluminium and timber sliding doors up to 280kg

Manufactured to offer superior corrosion resistance & durability

High performance roller with Ryvelin tyre and 'ZZ' ground precision bearing with dust seal

Fully adjustable carriage gives 8.5mm height adjustment

Stainless steel pivot pins and bearing axles

DORIC'S RANGE OF
HIGH PERFORMANCE ROLLERS

INNOVATORS

OF HARDWARE FOR WINDOWS AND DOORS

SLIDING_DOOR_LOCKS_DAP.v1.1-14.05.2020

SYDNEY

38 Redfern St,
Wetherill Park
Sydney, NSW 2164
Australia
Ph: +61 2 9609 2555
www.doric.com.au

AUCKLAND

26/C Triton Drive,
Albany, North Shore,
New Zealand 0632
Auckland
Ph: +64 9 415 5535
www.doricnz.co.nz

KUALA LUMPUR

No.17 Jalan 51/203A,
Kawasan Perindustrian Tiong Nam,
Seksyen 51, 46050 Petaling Jaya,
Selangor, Malaysia
Ph: +603 777 33 628
www.doric.com.my



**ALCHIN
LONG
GROUP**



SLIDING DOOR | **LOCKS &
ACCESSORIES**